

# Technical data sheet



Product features

## Open stand mobile 60x51

Model

SAP Code

00003162



– Material: Stainless steel

# Technical data sheet



Technical drawing

Open stand mobile 60x51

Model

SAP Code

00003162

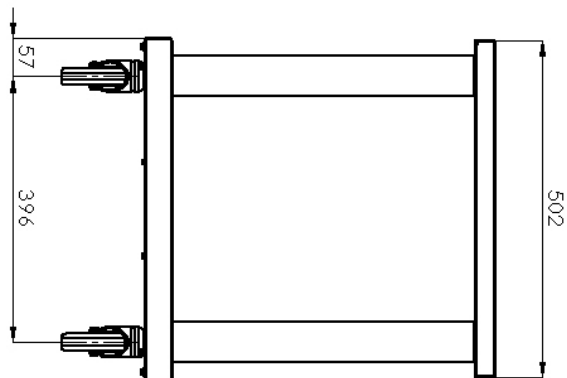
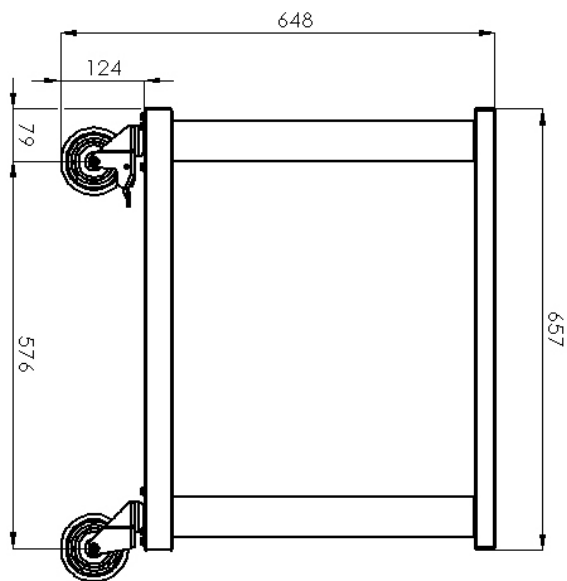

# Technical data sheet



Technical parameters

## Open stand mobile 60x51

Model

SAP Code

00003162

**1. SAP Code:**

00003162

**6. Gross Width [mm]:**

670

**2. Net Width [mm]:**

520

**7. Gross depth [mm]:**

520

**3. Net Depth [mm]:**

670

**8. Gross Height [mm]:**

660

**4. Net Height [mm]:**

650

**9. Gross Weight [kg]:**

21.00

**5. Net Weight [kg]:**

20.50

**10. Material:**

Stainless steel